

**50ZPB**  
**Single- Packaged Air Conditioner System**  
**With R- 410A Refrigerant Single Phase**  
**2 to 5 Nominal Tons (Sizes 024- 060)**

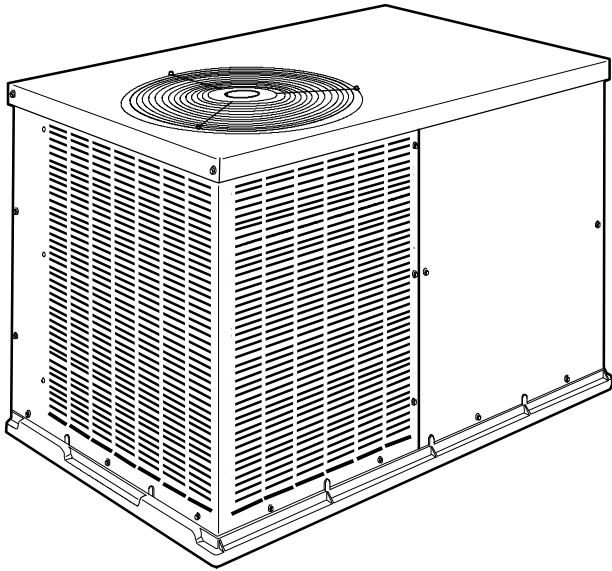

## Product Data



**Unit 50ZPB**

A10165

The 50ZPB unit is a packaged air conditioner for manufactured housing, residential, and light commercial applications. The 50ZPB unit design is the result of our firm commitment to the development of the finest air conditioners that modern technology can offer.

The 50ZPB unit is built in one basic cabinet size and features a round or rectangular side-by-side duct configuration.

### FEATURES/BENEFITS

**FACTORY-ASSEMBLED PACKAGE** is a compact, fully self-contained, electric cooling unit with horizontal supply and return ducts. The 50ZPB units are available in a variety of standard cooling sizes to meet residential and light commercial requirements. Unit installs easily on a ground level pad.

**EASY TO INSTALL** - 50ZPB units are small, compact, and easy to handle. Every 50ZPB unit has an identical 32 x 51-in. (813 x 1295 mm) footprint to make planning simple. The concise design uses less sheet metal and makes the 50ZPB units lighter than other units. The unit can be easily positioned on the job site with the hand holds built into the unit basepan.

**AERODYNAMIC FAN BLADE DESIGN** reduces the overall sound now as low as 72dBA.

**SERVICE ACCESS** makes installation and maintenance quicker and easier. The 50ZPB units are designed to be serviced from both the side and front. The design allows easy access for installation and maintenance procedures on the unit. Routine maintenance tasks such as coil cleaning are sped up with the multiple access side panels.

**NO-RUST BASEPAN WITH INTEGRATED DRAIN PAN** is standard on all units. The 50ZPB units feature a tough, hightech, composite material basepan with integrated drain pan. The composite material eliminates the potential problems of rust and premature replacement which are common with standard metal basepans.

**DURABLE PRE-PAINTED STEEL CABINET** protects against harsh weather. The watertight construction and corrosion-resistant finish of the 50ZPB unit will keep it looking like new for years. The paint treatment process ensures quality protection against the elements. A compact, low-profile design utilizes a louvered coil enclosure for protection against vandalism and hail damage.

**INDOOR AIR QUALITY** is designed into the 50ZPB units. A sloped drain pan minimizes the amount of standing water inside the unit, which limits mold and mildew growth. The drain pan is made of a rust-proof material and will not deteriorate or release foreign matter into the airstream.

**LIGHTWEIGHT, COMPACT CONSTRUCTION** is ideal for manufactured housing and residential applications. The 50ZPB unit is one of the lightest, most compact packaged units ever designed. Its light weight (286 lb [130 kg]) for the 50ZPB024 unit) makes the unit easier to handle. The low height keeps ductwork connections to a minimum and makes units less visible.

The 50ZPB units utilize a structural beam design to form the four sides of the cabinet. Only 12 different pieces of sheet metal are used in the unit construction to simplify the unit for greater reliability.

**EFFICIENT, DEPENDABLE PERFORMANCE** with durable compressors designed for efficiency. The 50ZPB units offer up to 13.5 SEER (Seasonal Energy Efficiency Ratio) cooling performance efficiencies. This performance level can reduce cooling expenses by as much as 30% compared to older cooling equipment.

**DURABLE, DEPENDABLE, COMPRESSORS** are designed for high efficiency. Each compressor is hermetically sealed against contamination to help promote longer life and dependable operation. Vibration isolation provides quiet operation. Compressors have internal overcurrent protection.

**DIRECT-DRIVE MULTISPEED, BLOWER MOTOR** is standard on all models. It's high efficiency design ensures high performance with most duct systems.

**DIRECT-DRIVE, PSC CONDENSER-FAN MOTORS** are designed to help reduce energy consumption and provide for cooling operation down to 40°F (4.4° C).

**REFRIGERANT SYSTEM** is designed to provide dependability. Liquid refrigerant filter driers are used to promote clean, unrestricted operation. Each unit leaves the factory with a full refrigerant charge. Refrigerant service connections make checking operating pressures easier.

**ACCESSORY ELECTRIC HEATERS** — A variety of accessory electric heaters are available for the 50ZPB units. These heaters are comprised of a separate heater module mounted on the blower inlet and remote mounted controls located in the unit control box. Single point electrical connections are available for powering both the heater and the unit.

## TABLE OF CONTENTS

	Page
FEATURES/BENEFITS .....	1-2
MODEL NUMBER NOMENCLATURE .....	2
AHRI CAPACITIES .....	3
PHYSICAL DATA .....	3
ACCESSORIES .....	4
BASE UNIT DIMENSIONS .....	5-6
SELECTION PROCEDURE .....	7
PERFORMANCE DATA .....	8-12
TYPICAL WIRING SCHEMATICS .....	13
ELECTRICAL DATA .....	15
OPERATING SEQUENCE .....	15
APPLICATION DATA .....	16
TYPICAL INSTALLATION .....	15
GUIDE SPECIFICATIONS .....	17

**50ZPB**

## MODEL NUMBER NOMENCLATURE

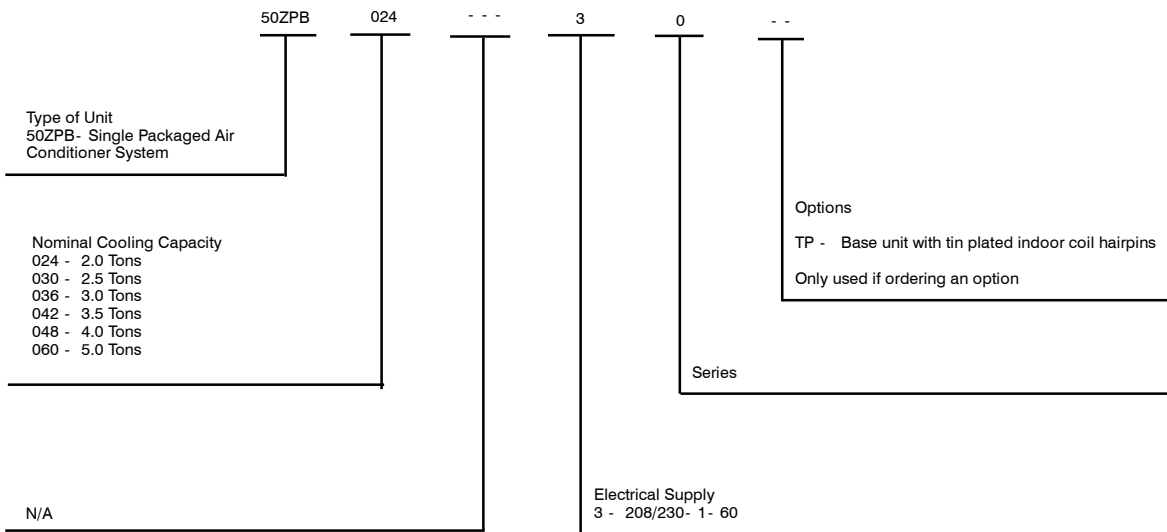

Use of the AHRI Certified TM Mark indicates a manufacturer's participation in the program For verification of certification for individual products, go to [www.ahridirectory.org](http://www.ahridirectory.org).



# AHRI\* CAPACITY RATINGS

## Cooling Capacities and Efficiencies

UNIT 50ZPB	NOMINAL TONS	STANDARD CFM	NET COOLING CAPACITY AT 95° F (35° c) (Btuh)	EER†	SEER**
024	2	800	22800	11.5	13.5
030	2.5	1000	28400	11.5	13.2
036	3	1200	34800	11.5	13.5
042	3.5	1400	40500	11.5	13.5
048	4	1600	46500	11	13.2
060	5	1750	55500	11	13.2

**LEGEND**

dB - - - Sound Levels (decibels)  
 db—Dry Bulb  
 SEER—Seasonal Energy Efficiency Ratio  
 wb—Wet Bulb  
 COP - - - Coefficient of Performance  
 \* Air Conditioning Heating & Refrigeration Institute  
 † At "A" conditions - - 80° F (26.7° C) indoor db/67° F (19.4° C) indoor wb & 95° F (35° C) outdoor db.  
 \*\* Rated in accordance with U.S. Government DOE Department of Energy) test procedures and/or AHRI Standards 210/240 - - - 08.

**Notes:**

1. Ratings are net values, reflecting the effects of circulating fan heat. Ratings are based on:  
 Cooling Standard: 80° F (26.7° C) db, 67° Fwb (19.4° C) indoor entering - - - air temperature and 95° F db (35° C) outdoor entering - - - air temperature.  
 2. Before purchasing this appliance, read important energy cost and efficiency information available from your retailer.

**50ZPB**

### A-Weighted Sound Power Level (dBA)

UNIT 50ZPB	STANDARD RATING (dBA)	TYPICAL OCTAVE BAND SPECTRUM (dBA without tone adjustment)							
		125	250	500	1000	2000	4000	8000	
024	72	58	66.5	63.5	64.5	60.5	57.5	51.5	
030	76	62.5	68	64.5	68	67.5	58.5	53	
036	77	67.5	70	70	70.5	66	60.5	55	
042	76	65	69	68.5	70	67.5	63	58.5	
048	77	68.5	68	71	70.5	65.5	61.5	55	
060	80	66.5	70	75.5	75.5	71.5	66.5	58	

### PHYSICAL DATA

UNIT SIZE	024	030	036	042	048	060
NOMINAL CAPACITY (ton)	2	2.5	3	3.5	4	5
SHIPPING WEIGHT (lb) (kg)	286 130	298 136	329 150	352 160	354 161	402 183
COMPRESSOR TYPE	RECIPROCATING			SCROLL		
REFRIGERANT	R-410A					
REFRIGERANT QUANTITY (lb) QUANTITY (kg)	3.3 1.5	4.0 1.8	5.3 2.4	5.9 2.7	5.0 2.3	6.1 2.77
METERING DEVICE ID	Piston					TXV
ORIFICE OD (in.) (mm)	0.059 1.50	0.059 1.50	0.067 1.70	0.073 1.85	0.082 2.08	N/A
OUTDOOR COIL ROWS...FINS/in. FACE AREA (sq. ft)	1...20 9.1	1...20 9.1	2...20 9.1	2...20 10.2	2...20 10.2	2...20 13.0
OUTDOOR FAN NOMINAL AIRFLOW (CFM) DIAMETER (in.) DIAMETER (mm) MOTOR HP (RPM)	2400 20 508 1/8 (800)	2400 20 508 1/8 (800)	2700 20 508 1/4 (1050)	2700 20 508 1/4 (1050)	2700 20 508 1/4 (1050)	3000 20 508 1/3 (1100)
INDOOR COIL ROWS...FINS/in. FACE AREA (sq. ft)	2...12 4.3	3...12 4.3	3...12 4.3	3...12 4.9	3...12 4.9	3...12 6.1
INDOOR BLOWER NOMINAL COOLING AIRFLOW (CFM) NOMINAL SIZE L x D (in.) (mm) MOTOR (HP)	800 10 x 8 254 x 203 1/3	1000 10 x 8 254 x 203 1/3	1200 11 x 9 279 x 229 1/2	1400 11 x 9 279 x 229 1/2	1600 11 x 9 279 x 229 3/4	1750 10.5 x 12 267 x 305 1
HIGH-PRESSURE SWITCH (psig) CUTOUT RESET (AUTO)	650 +/- 15 420 +/- 25					
RETURN-AIR FILTERS THROWAWAY (in.) (mm)	20x20x1 508x508x25	20x24x1 508x610x25	24x30x1 610x762x25		24x36x1 610x914x25	

\*Required filter sizes shown are based on the AHRI (Air Conditioning, Heating and Refrigeration Institute) rated airflow at a velocity of 300 ft/min for throwaway type or 450 ft/min for high capacity type. Recommended filters are 1 - in. (25.4 mm) thick.

# OPTIONS AND ACCESSORIES

ITEM	DESCRIPTION	FACTORY INSTALLED OPTION	FIELD INSTALLED ACCESSORY
Coil Options	Base unit with tin plated indoor coil hairpins	X	
Compressor Start Kit	Compressor Start Kit assists compressor start- up by providing additional starting torque on sing phase units only.		X
Corporate Thermostats	Thermostats provide control for the system heating and cooling functions.		X
Crankcase Heater	Crankcase Heater provides anti- floodback protection for low- load cooling applications.		X*
Electric Heaters	Electric Heat Supplement		X
Low Ambient Kit	Low Ambient Kit (Motormaster II Control) allows the use of mech- anical cooling down to outdoor temperatures as low as 0°F (- 18° C) when properly installed.		X
Time Guard II	Automatically prevents the compressor from restarting for at least 4 minutes and 45 seconds after shutdown of the compressor. Not required when a corporate programmable thermostat is applied.		X

\*Refer to Price Page for application detail.

## Accessory Electric Heaters

CATALOG ORDERING NO.	NOMINAL CAPACITY (kW)	USED WITH SIZES							
		CIRCUIT BREAKER (Yes/No)	STAGES	024	030	036	042	048	060
<b>ELECTRIC HEATERS (208/230 - SINGLE PHASE - 60Hz)</b>									
CPHEATER125A00	3.8 / 5.0	No	1	√	√	√	√	√	√
CPHEATER126A00	3.8 / 5.0	Yes	1	√	√	√	√	√	√
CPHEATER127A00	5.6 / 7.5	No	2	√	√	√	√	√	√
CPHEATER128A00	5.6 / 7.5	Yes	2	√	√	√	√	√	√
CPHEATER129A00	7.5 / 10.0	No	2	√	√	√	√	√	
CPHEATER130A00	7.5 / 10.0	Yes	2	√	√	√	√	√	√
CPHEATER131A00	11.3 / 15.0	Yes	2			√	√	√	√
CPHEATER132A00	15.0 / 20.0	Yes	2					√	√

√ =Approved combination

## Multiplication Factors

HEATER kW RATING	VOLTAGE DISTRIBUTION	MULTIPLICATION FACTOR
<b>240</b>	200	.69
	208	.75
	230	.92
	240	1.00

Example: 15.0 kW (at 240v) heater on 208v  
 = 15.0 (.75 mult factor)  
 = 11.25 capacity at 208v

50ZPB

# DIMENSIONAL DRAWINGS — 50ZPB024-036

UNIT	ELECTRICAL CHARACTERISTICS	UNIT HEIGHT			CENTER OF GRAVITY IN [MM]		
		LBS.	KG.	A	X	Y	Z
50ZPB024-31	208/230-1-60	237	108	30-1/8 [765]	14 [356]	19 [483]	14 [356]
50ZPB030-31	208/230-1-60	249	113	30-1/8 [765]	14 [356]	19 [483]	14 [356]
50ZPB036-31	208/230-1-60	279	127	30-1/8 [765]	14 [356]	19 [483]	14 [356]

**REQUIRED CLEARANCES TO COMBUSTIBLE MATL.**

INCHES [MM]

TOP OF UNIT.....0

BOTTOM OF UNIT.....0

SIDE OF UNIT WITH DUCT OPENINGS.....0

SIDE OF UNIT OPPOSITE DUCT OPENINGS.....0

**NEC. REQUIRED CLEARANCES**

INCHES [MM]

BETWEEN UNITS, POWER ENTRY SIDE.....42.0 [1067]

UNIT AND UNGROUNDED SURFACES, POWER ENTRY SIDE.....36.0 [914]

UNITS ON CONCRETE OR MASONRY WALLS AND OTHER GROUNDED SURFACES, POWER ENTRY SIDE.....42.0 [1067]

**REQUIRED CLEARANCE FOR SERVICING**

INCHES [MM]

TOP OF UNIT, OPPOSITE DUCT OPENINGS.....36.0 [914]

BOTTOM OF UNIT.....0

SIDE OF UNIT WITH POWER ENTRY.....30.0 [762]

SIDE OF UNIT OPPOSITE POWER ENTRY (EXCEPT FOR NEC REQUIREMENTS)

**NOTE:** CLEARANCES MUST BE MAINTAINED TO PREVENT RECIRCULATION OF AIR FROM OUTDOOR FAN DISCHARGE. A REMOVABLE FENCE OR BARRICADE REQUIRES NO CLEARANCE.

**NOTE:** SUPERCEDES DRAWING 50ZP500716 REV. C.

DIMENSIONS IN [ ] ARE IN MM

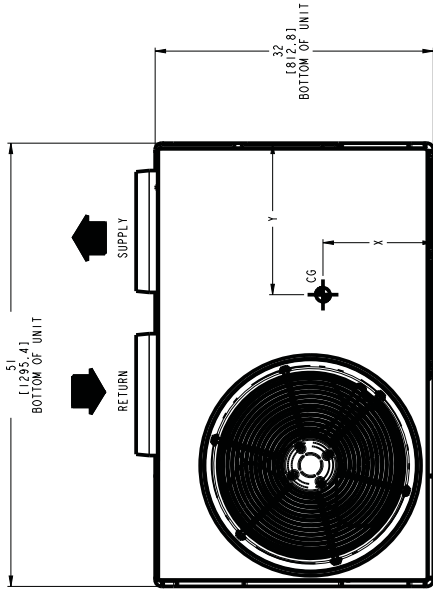

**TOP VIEW**

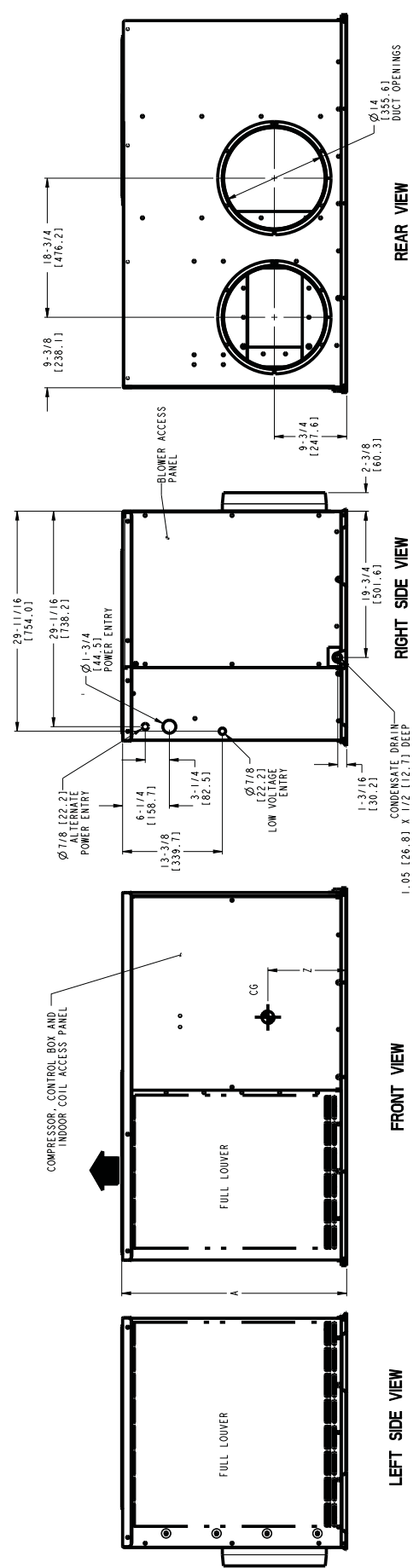

**LEFT SIDE VIEW**

**FRONT VIEW**

**RIGHT SIDE VIEW**

**REAR VIEW**

REV	50ZP500991
-	-



# DIMENSIONAL DRAWINGS — 50ZPB042-060

50ZPB

UNIT	ELECTRICAL CHARACTERISTICS	CENTER OF GRAVITY IN [MM]			UNIT WT.		UNIT HEIGHT		
		LBS.	KG.	A	X	Y	Z		
50ZPB042---31	208/230-1-60	303	138	34-1/8 [867]	14 [356]	19 [483]	16 [406]		
50ZPB048---31	208/230-1-60	305	139	34-1/8 [867]	14 [356]	19 [483]	16 [406]		
50ZPB060---32	208/230-1-60	352	160	42-1/8 [1070]	14 [356]	19 [483]	19-3/4 [503]		

**REQUIRED CLEARANCES TO COMBUSTIBLE MATL.**

TOP OF UNIT..... INCHES [MM].....0

BOTTOM OF UNIT..... INCHES [MM].....0

UNIT WITH DUCT OPENINGS..... INCHES [MM].....0

SIDE OF UNIT..... INCHES [MM].....0

SIDE OF UNIT OPPOSITE DUCT OPENINGS..... INCHES [MM].....0

**NEC. REQUIRED CLEARANCES.**

BETWEEN UNITS, POWER ENTRY SIDE..... INCHES [MM].....42.0 [1067]

BETWEEN UNITS, POWER ENTRY SIDE..... INCHES [MM].....42.0 [1067]

UNIT AND GROUND SURFACE, POWER ENTRY SIDE..... INCHES [MM].....36.0 [914]

UNIT AND BLOCK OR CONCRETE WALLS AND OTHER GROUND SURFACES, POWER ENTRY SIDE..... INCHES [MM].....42.0 [1067]

**REQUIRED CLEARANCE FOR SERVICING**

TOP OF UNIT..... INCHES [MM].....30.0 [762]

SIDE OF UNIT OPPOSITE DUCT OPENINGS..... INCHES [MM].....30.0 [762]

SIDE OF UNIT WITH POWER ENTRY..... INCHES [MM].....30.0 [762]

(EXCEPT FOR NEC REQUIREMENTS)

**NOTE:** CLEARANCES MUST BE MAINTAINED TO PREVENT RECIRCULATION OF AIR FROM OUTDOOR FAN DISCHARGE. A REMOVABLE FENCE OR BARRICADE REQUIRES NO CLEARANCE.

**NOTE:** SUPERCEDES DRAWING 50ZP500777 REV. C.

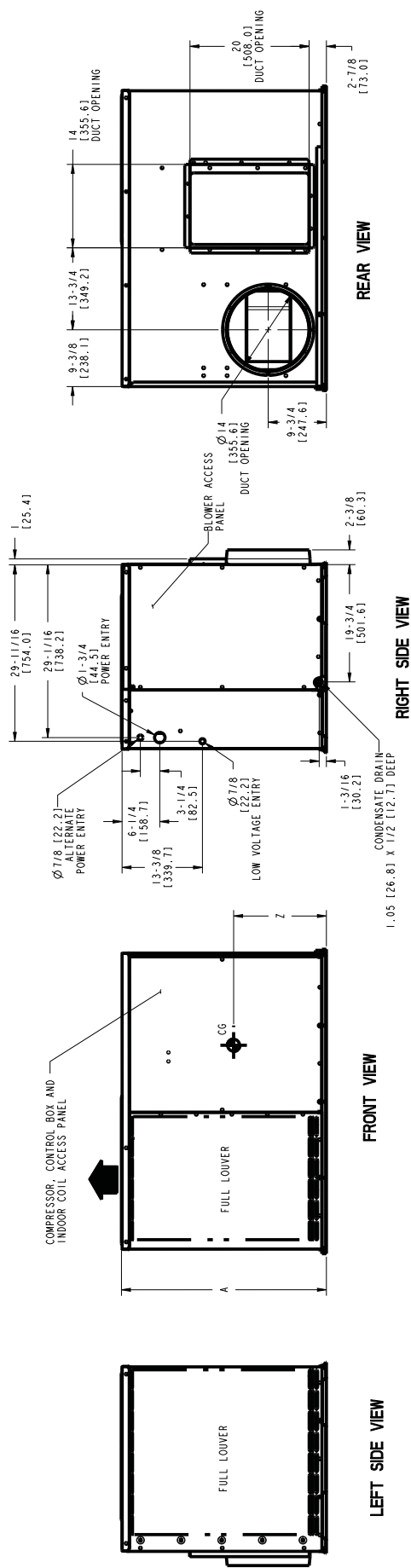
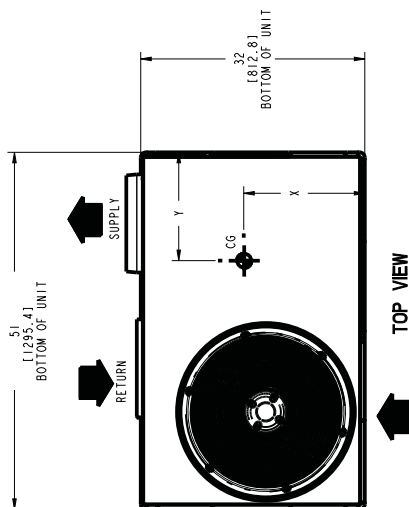

DIMENSIONS IN [ ] ARE IN MM

REV	-
-----	---

**SELECTION PROCEDURE**

**A. DETERMINE COOLING AND HEATING REQUIREMENTS AT DESIGN CONDITIONS.**

Given:

- Required Cooling Capacity (TC) . . . . . 34,000 Btuh
- Sensible Heat Capacity (SHC) . . . . . 25,000 Btuh
- Required Heating Capacity . . . . . 15,000 Btuh
- Outdoor Entering- Air Temperature . . . . . 95° F (35° C)
- Indoor Entering- Air Temperature . . . . . 80° F edb (26.7° C);  
67° F (19.4° C) ewb
- Indoor- Air Quantity . . . . . 1200 CFM
- External Static Pressure . . . . . 0.20 IN. W.C.
- Electrical Characteristics (V- Ph- Hz) . . . . . 230-1-60

**B. SELECT UNIT BASED ON REQUIRED COOLING CAPACITY.**

Enter Cooling Capacities table at condenser entering temperature of 95° F (35° C), indoor air entering at 1200 CFM and 67° F (19.4° C) ewb. The 50ZPB036 unit provides a total cooling capacity of 34,500 Btuh and a sensible heat capacity of 26,040 Btuh.

For indoor-air temperature other than 80° F (26.7° C) edb, calculate sensible heat capacity correction, as required, using the formula found following the Cooling Capacities tables.

**NOTE:** Unit ratings are net capacities.

**C. SELECT ELECTRIC HEAT.**

The required heating capacity is 15,000 Btuh (given). Determine the electric heat capacity in kW.

$$\frac{15,000 \text{ Btuh}}{3414 \text{ Btuh/kW}} = 3.8 \text{ kW of heat required}$$

Enter the Accessory Electric Heater table on page 4 for 208/230, single-phase, 50ZPB036 unit. The 5-kW heater at 240v most closely satisfies the heating required. To calculate kW at 230 V, multiply the heater kW by multiplication factor 0.92 found in the Multiplication Factors table on page 4.

$$5 \text{ kW} \times 0.92 = 4.6 \text{ kW}$$

$$4.6 \text{ kW} \times 3414 \text{ Btuh/kW} = 15,704 \text{ Btuh}$$

**D. DETERMINE FAN SPEED AND POWER REQUIREMENTS AT DESIGN CONDITIONS.**

Before entering the air delivery tables, calculate the total static pressure required. From the given, Filter Pressure Drop table, and the Accessory Electric Heat Pressure Drop table find:

External static pressure	0.20 IN. W.C.
Filter	0.10 IN. W.C.
Electric Heat	<u>0.04</u> IN. W.C.
Total static pressure	0.34 IN. W.C.

Enter the table for Dry Coil Air Delivery — Horizontal Discharge. At 0.4 IN. W.C. external static pressure and medium speed, the motor delivers 1236 CFM.

**50ZPB**

**PERFORMANCE DATA**

**Cooling Capacities**

**50ZPB024**

EVAPORATOR AIR		CONDENSER ENTERING AIR TEMPERATURES ° F (° C)																	
CFM / BF	EWB ° F (° C)	75 (24)			85 (29)			95 (35)			105 (41)			115 (46)			125 (52)		
		Capacity MBtuh	Total Sys KW	Total Sys KW	Capacity MBtuh	Total Sys KW	Total Sys KW	Capacity MBtuh	Total Sys KW	Total Sys KW	Capacity MBtuh	Total Sys KW	Total Sys KW	Capacity MBtuh	Total Sys KW	Total Sys KW	Capacity MBtuh	Total Sys KW	Total Sys KW
700 / 0.08	57 (14)	21.75	21.75	1.68	20.46	20.46	1.79	19.11	19.11	1.88	17.51	17.51	1.97	15.70	15.70	2.05	13.85	13.85	2.13
	62 (17)	22.93	20.43	1.69	21.23	19.61	1.80	19.52	18.78	1.89	17.54	17.54	1.97	15.73	15.73	2.05	13.87	13.87	2.13
	63* (17)	23.48	16.83	1.69	21.76	16.02	1.80	19.98	15.21	1.90	17.79	14.23	1.97	15.22	13.13	2.03	12.66	12.02	2.09
	67 (19)	25.82	17.68	1.72	24.03	16.90	1.84	22.20	16.11	1.95	20.19	15.27	2.04	17.47	14.17	2.10	14.80	13.11	2.16
	72 (22)	28.85	14.82	1.72	27.06	14.10	1.86	25.15	13.35	1.99	23.20	12.60	2.11	20.70	11.65	2.20	17.89	10.63	2.26
800 / 0.10	57 (14)	22.85	22.85	1.70	21.49	21.49	1.81	20.12	20.12	1.92	18.49	18.49	2.01	16.57	16.57	2.09	14.64	14.64	2.17
	62 (17)	23.61	21.88	1.71	21.90	21.04	1.82	20.21	20.15	1.92	18.52	18.52	2.01	16.60	16.60	2.09	14.67	14.67	2.17
	63* (17)	24.16	17.84	1.71	22.38	17.02	1.83	20.53	16.20	1.93	18.30	15.22	2.00	15.65	14.09	2.06	13.07	12.94	2.12
	67 (19)	26.56	18.75	1.73	24.70	17.97	1.86	22.80	17.17	1.98	20.74	16.32	2.07	17.96	15.21	2.13	15.23	14.13	2.19
	72 (22)	29.53	15.47	1.73	27.69	14.75	1.87	25.78	14.01	2.01	23.74	13.26	2.13	21.28	12.36	2.23	18.33	11.28	2.29
900 / 0.11	57 (14)	23.82	23.82	1.72	22.41	22.41	1.84	20.98	20.98	1.95	19.36	19.36	2.04	17.32	17.32	2.12	15.32	15.32	2.21
	62 (17)	24.21	23.22	1.73	22.54	22.34	1.84	21.01	21.01	1.95	19.39	19.39	2.05	17.35	17.35	2.12	15.34	15.34	2.21
	63* (17)	24.70	18.77	1.73	22.87	17.94	1.85	20.97	17.11	1.95	18.73	16.14	2.02	16.03	14.99	2.08	13.55	13.55	2.15
	67 (19)	27.13	19.72	1.74	25.23	18.95	1.88	23.28	18.14	2.00	21.15	17.29	2.10	18.35	16.19	2.15	15.60	15.06	2.21
	72 (22)	30.06	16.04	1.74	28.19	15.34	1.89	26.23	14.59	2.03	24.15	13.85	2.15	21.74	12.99	2.25	18.72	11.91	2.32

See Legend and Notes on page 11.

**50ZPB030**

EVAPORATOR AIR		CONDENSER ENTERING AIR TEMPERATURES ° F (° C)																	
CFM / BF	EWB ° F (° C)	75 (24)			85 (29)			95 (35)			105 (41)			115 (46)			125 (52)		
		Capacity MBtuh	Total Sys KW	Total Sys KW	Capacity MBtuh	Total Sys KW	Total Sys KW	Capacity MBtuh	Total Sys KW	Total Sys KW	Capacity MBtuh	Total Sys KW	Total Sys KW	Capacity MBtuh	Total Sys KW	Total Sys KW	Capacity MBtuh	Total Sys KW	Total Sys KW
875 / 0.08	57 (14)	27.70	27.70	2.10	26.09	26.09	2.24	24.54	24.54	2.39	22.86	22.86	2.53	20.94	20.94	2.68	18.67	18.67	2.78
	62 (17)	28.87	26.13	2.11	26.87	25.20	2.25	24.86	24.24	2.39	22.90	22.90	2.53	21.01	21.01	2.68	18.71	18.71	2.78
	63* (17)	29.43	21.34	2.12	27.40	20.44	2.26	25.31	19.50	2.40	23.09	18.54	2.53	20.46	17.41	2.65	17.35	16.07	2.71
	67 (19)	31.94	22.16	2.16	29.92	21.34	2.31	27.79	20.47	2.45	25.55	19.56	2.59	23.11	18.62	2.73	20.00	17.41	2.85
	72 (22)	34.89	18.05	2.22	32.92	17.29	2.37	30.78	16.48	2.52	28.49	15.63	2.66	26.08	14.75	2.81	23.50	13.86	2.94
1000 / 0.09	57 (14)	29.04	29.04	2.14	27.44	27.44	2.28	25.75	25.75	2.43	24.02	24.02	2.58	22.11	22.11	2.73	19.72	19.72	2.86
	62 (17)	29.67	28.01	2.15	27.71	27.09	2.29	25.79	25.79	2.43	24.06	24.06	2.58	22.15	22.15	2.73	19.75	19.75	2.86
	63* (17)	30.14	22.60	2.16	28.07	21.72	2.29	25.91	20.79	2.43	23.64	19.84	2.57	21.07	18.77	2.70	17.89	17.39	2.76
	67 (19)	32.62	23.42	2.20	30.57	22.64	2.34	28.40	21.80	2.49	26.09	20.91	2.63	23.63	19.99	2.76	20.57	18.84	2.89
	72 (22)	35.51	18.76	2.26	33.50	18.03	2.41	31.30	17.23	2.55	28.96	16.39	2.70	26.49	15.52	2.84	23.87	14.64	2.97
1125 / 0.10	57 (14)	30.14	30.14	2.18	28.51	28.51	2.33	26.77	26.77	2.48	24.95	24.95	2.63	22.98	22.98	2.77	20.62	20.62	2.91
	62 (17)	30.38	29.71	2.18	28.50	28.50	2.33	26.81	26.81	2.48	24.99	24.99	2.63	23.01	23.01	2.77	20.66	20.66	2.92
	63* (17)	30.67	23.75	2.19	28.57	22.91	2.33	26.36	22.00	2.47	24.07	21.06	2.60	21.58	20.02	2.74	18.42	18.42	2.82
	67 (19)	33.13	24.56	2.23	31.04	23.83	2.37	28.85	23.02	2.52	26.47	22.15	2.66	24.02	21.25	2.80	21.06	20.15	2.93
	72 (22)	35.96	19.38	2.29	33.93	18.68	2.44	31.69	17.89	2.59	29.29	17.07	2.73	26.79	16.21	2.88	24.15	15.34	3.01

See Legend and Notes on page 11.



# COOLING CAPACITIES (CONT)

## 50ZPB036

EVAPORATOR AIR		CONDENSER ENTERING AIR TEMPERATURES ° F (° C)																		
		75 (24)			85 (29)			95 (35)			105 (41)			115 (46)			125 (52)			
		Capacity MBtuh	Total Sys KW	Total Sys KW	Capacity MBtuh	Total Sys KW	Total Sys KW	Capacity MBtuh	Total Sys KW	Total Sys KW	Capacity MBtuh	Total Sys KW	Total Sys KW	Capacity MBtuh	Total Sys KW	Total Sys KW	Capacity MBtuh	Total Sys KW	Total Sys KW	
CFM / BF	EWB ° F (° C)	Total	Sens	Total	Sens	Total	Sens	Total	Sens	Total	Sens	Total	Sens	Total	Sens	Total	Sens	Total	Sens	
		1050 / 0.07	57 (14)	33.50	33.50	2.56	31.67	31.67	2.73	29.79	29.79	2.90	27.87	27.87	3.09	25.50	25.50	3.24	22.74	22.74
62 (17)	34.88		30.87	2.59	32.52	29.76	2.75	30.15	28.64	2.91	27.89	27.89	3.08	25.55	25.55	3.24	22.79	22.79	3.38	19.06
63* (17)	35.66		25.30	2.59	33.23	24.20	2.76	30.72	23.10	2.93	28.18	22.01	3.10	24.88	20.82	3.21	21.13	19.06	3.31	19.06
1200 / 0.08	67 (19)	38.95	26.43	2.62	36.53	25.45	2.81	33.96	24.41	3.00	31.27	23.33	3.19	28.29	22.15	3.35	24.34	20.62	3.44	16.73
	72 (22)	42.84	21.73	2.66	40.56	20.88	2.86	38.04	19.94	3.05	35.31	18.94	3.25	32.43	17.90	3.44	29.05	16.73	3.63	16.73
	57 (14)	35.21	35.21	2.61	33.29	33.29	2.78	31.31	31.31	2.96	29.28	29.28	3.15	26.98	26.98	3.31	24.03	24.03	3.45	24.03
1350 / 0.10	62 (17)	35.96	33.14	2.61	33.61	32.04	2.79	31.34	31.34	2.96	29.33	29.33	3.15	27.03	27.03	3.32	24.07	24.07	3.45	24.07
	63* (17)	36.64	26.87	2.62	34.15	25.80	2.80	31.52	24.66	2.96	28.84	23.54	3.13	25.63	22.20	3.25	21.82	20.59	3.36	20.59
	67 (19)	39.91	28.02	2.64	37.47	27.09	2.83	34.80	26.04	3.03	32.03	24.96	3.21	29.00	23.82	3.39	25.04	22.28	3.49	22.28
1500 / 0.12	72 (22)	43.68	22.64	2.68	41.37	21.83	2.88	38.79	20.91	3.08	36.02	19.92	3.28	33.06	18.88	3.47	29.80	17.78	3.65	17.78
	57 (14)	36.67	36.67	2.63	34.69	34.69	2.82	32.64	32.64	3.01	30.51	30.51	3.21	28.17	28.17	3.38	25.11	25.11	3.51	25.11
	62 (17)	36.96	35.26	2.63	34.70	34.70	2.82	32.69	32.69	3.02	30.56	30.56	3.21	28.21	28.21	3.39	25.16	25.16	3.51	25.16
1575 / 0.14	63* (17)	37.41	28.32	2.64	34.86	27.26	2.82	32.18	26.14	3.00	29.45	25.01	3.17	26.27	23.88	3.29	22.47	22.36	3.40	22.36
	67 (19)	40.64	29.47	2.66	38.16	28.58	2.86	35.47	27.57	3.05	32.62	26.49	3.24	29.60	25.37	3.42	25.69	23.84	3.54	23.84
	72 (22)	44.28	23.43	2.70	41.98	22.67	2.90	39.36	21.78	3.10	36.54	20.81	3.30	33.54	19.78	3.50	30.27	18.71	3.68	18.71

See Legend and Notes on page 11.

## 50ZPB042

EVAPORATOR AIR		CONDENSER ENTERING AIR TEMPERATURES ° F (° C)																		
		75 (24)			85 (29)			95 (35)			105 (41)			115 (46)			125 (52)			
		Capacity MBtuh	Total Sys KW	Total Sys KW	Capacity MBtuh	Total Sys KW	Total Sys KW	Capacity MBtuh	Total Sys KW	Total Sys KW	Capacity MBtuh	Total Sys KW	Total Sys KW	Capacity MBtuh	Total Sys KW	Total Sys KW	Capacity MBtuh	Total Sys KW	Total Sys KW	
CFM / BF	EWB ° F (° C)	Total	Sens	Total	Sens	Total	Sens	Total	Sens	Total	Sens	Total	Sens	Total	Sens	Total	Sens	Total	Sens	
		1225 / 0.11	57 (14)	39.06	39.06	2.87	36.97	36.97	3.13	34.88	34.88	3.38	32.62	32.62	3.61	29.51	29.51	3.81	26.60	26.60
62 (17)	40.61		36.69	2.89	37.94	35.42	3.16	35.31	34.13	3.40	32.64	32.64	3.61	29.57	29.57	3.81	26.65	26.65	4.03	26.65
63* (17)	41.47		29.95	2.89	38.74	28.71	3.17	35.92	27.45	3.41	32.91	26.13	3.62	28.69	24.32	3.77	24.73	22.64	3.93	22.64
1400 / 0.12	67 (19)	45.26	31.27	2.91	42.51	30.12	3.20	39.63	28.95	3.47	36.63	27.72	3.73	32.67	26.16	3.95	28.47	24.50	4.11	24.50
	72 (22)	49.83	25.62	2.94	47.14	24.58	3.25	44.25	23.48	3.55	41.16	22.35	3.82	37.98	21.16	4.08	33.92	19.76	4.34	19.76
	57 (14)	40.98	40.98	2.93	38.81	38.81	3.20	36.61	36.61	3.46	34.26	34.26	3.71	31.14	31.14	3.92	28.04	28.04	4.13	28.04
1575 / 0.14	62 (17)	41.80	39.32	2.93	39.17	38.04	3.20	36.62	36.62	3.46	34.32	34.32	3.72	31.20	31.20	3.92	28.07	28.07	4.13	28.07
	63* (17)	42.51	31.75	2.93	39.70	30.51	3.21	36.82	29.27	3.46	33.72	27.95	3.70	29.50	26.16	3.84	25.47	24.42	4.00	24.42
	67 (19)	46.29	33.08	2.95	43.47	31.98	3.24	40.50	30.80	3.52	37.43	29.59	3.78	33.59	28.17	4.02	29.26	26.44	4.19	26.44
1575 / 0.14	72 (22)	50.78	26.66	2.98	48.03	25.64	3.30	45.06	24.55	3.59	41.93	29.41	3.88	38.64	22.25	4.14	34.69	20.95	4.39	20.95
	57 (14)	42.58	42.58	2.96	40.34	40.34	3.25	38.02	38.02	3.52	35.62	35.62	3.78	32.52	32.52	4.02	29.27	29.27	4.23	29.27
	62 (17)	42.89	41.73	2.97	40.34	40.34	3.25	38.08	38.08	3.52	35.68	35.68	3.78	32.57	32.57	4.02	29.32	29.32	4.23	29.32
1575 / 0.14	63* (17)	43.33	33.41	2.97	40.45	32.19	3.25	37.48	30.93	3.51	34.40	29.65	3.75	30.18	27.87	3.91	26.18	25.96	4.07	25.96
	67 (19)	47.06	34.74	2.98	44.19	33.68	3.29	41.17	32.52	3.57	38.07	31.33	3.83	34.35	30.00	4.07	29.94	28.26	4.26	28.26
	72 (22)	51.47	27.57	3.02	48.69	26.59	3.34	45.66	25.51	3.64	42.47	24.38	3.92	39.14	23.21	4.19	35.27	22.02	4.44	22.02

See Legend and Notes on page 11.

COOLING CAPACITIES (CONT)

50ZPB048

EVAPORATOR AIR		CONDENSER ENTERING AIR TEMPERATURES ° F (° C)																	
		75 (24)			85 (29)			95 (35)			105 (41)			115 (46)			125 (52)		
		CFM / BF	EWB ° F (° C)	Capacity MBtuh		Total Sys KW	Capacity MBtuh		Total Sys KW	Capacity MBtuh		Total Sys KW	Capacity MBtuh		Total Sys KW	Capacity MBtuh		Total Sys KW	
Total	Sens			Total	Sens		Total	Sens		Total	Sens		Total	Sens		Total	Sens		
1400 / 0.07	57 (14)	44.72	44.72	42.80	42.80	3.70	40.34	40.34	4.07	37.29	37.29	4.46	34.29	34.29	4.92	31.13	31.13	5.43	
	62 (17)	46.27	41.01	39.88	37.32	3.71	40.95	38.51	4.09	37.32	37.32	4.46	34.35	34.35	4.92	31.18	31.18	5.44	
	63* (17)	47.12	33.38	33.32	32.29	3.72	41.71	31.00	4.11	37.60	29.23	4.46	33.61	27.56	4.89	29.46	25.83	5.37	
	67 (19)	50.88	34.65	33.33	33.60	3.75	45.63	32.52	4.17	41.64	30.97	4.60	37.50	29.34	5.02	33.25	27.70	5.51	
	72 (22)	55.64	28.13	33.66	27.15	3.79	50.28	26.13	4.23	47.30	25.05	4.70	42.98	23.56	5.21	38.57	21.98	5.73	
1600 / 0.08	57 (14)	46.63	46.63	44.60	44.60	3.76	42.36	42.36	4.19	39.06	39.06	4.56	35.87	35.87	5.02	32.58	32.58	5.54	
	62 (17)	47.42	43.87	42.69	42.69	3.77	42.38	42.38	4.19	39.12	39.12	4.57	35.93	35.93	5.02	32.63	32.63	5.54	
	63* (17)	48.12	35.36	34.25	34.25	3.77	42.75	33.07	4.19	38.49	31.28	4.54	34.37	29.56	4.96	30.14	27.76	5.45	
	67 (19)	51.87	36.67	35.66	35.66	3.80	46.50	34.58	4.23	42.57	33.17	4.68	38.33	31.52	5.11	33.97	29.82	5.59	
	72 (22)	56.59	29.32	35.87	28.35	3.85	51.04	27.32	4.29	48.05	26.26	4.76	43.83	24.90	5.27	39.27	23.31	5.81	
1750 / 0.09	57 (14)	47.82	47.82	45.73	45.73	3.80	43.48	43.48	4.23	40.18	40.18	4.64	36.88	36.88	5.09	33.51	33.51	5.61	
	62 (17)	48.19	45.84	45.51	45.51	3.80	43.54	43.54	4.23	40.24	40.24	4.64	36.93	36.93	5.09	33.56	33.56	5.61	
	63* (17)	48.71	36.72	34.40	34.40	3.81	43.27	34.48	4.23	39.02	32.73	4.59	34.85	30.96	5.02	30.62	29.10	5.50	
	67 (19)	52.45	38.10	37.10	36.04	3.84	47.00	36.04	4.27	43.18	34.75	4.73	38.83	33.05	5.16	34.44	31.30	5.65	
	72 (22)	57.14	30.14	34.57	29.18	3.88	51.49	28.16	4.33	48.47	27.09	4.80	44.34	25.84	5.31	39.72	24.30	5.87	

See Legend and Notes on page 11.

50ZPB060

EVAPORATOR AIR		CONDENSER ENTERING AIR TEMPERATURES ° F (° C)																	
		75 (24)			85 (29)			95 (35)			105 (41)			115 (46)			125 (52)		
		CFM / BF	EWB	Capacity MBtuh		Total Sys KW	Capacity MBtuh		Total Sys KW	Capacity MBtuh		Total Sys KW	Capacity MBtuh		Total Sys KW	Capacity MBtuh		Total Sys KW	
Total	Sens			Total	Sens		Total	Sens		Total	Sens		Total	Sens		Total	Sens		
1750 / 0.07	57 (14)	56.20	56.20	53.53	53.53	4.13	50.72	50.72	4.96	47.75	47.75	5.46	44.62	44.62	6.02	41.35	41.35	6.66	
	62 (17)	57.67	52.85	54.51	50.86	4.15	51.26	48.81	4.97	47.91	46.63	5.46	44.67	44.67	6.03	41.40	41.40	6.66	
	63* (17)	58.61	42.84	41.02	41.02	4.16	55.35	41.97	4.98	48.43	37.29	5.47	44.69	35.35	6.02	40.89	33.42	6.65	
	67 (19)	62.66	44.31	42.22	42.46	4.22	59.12	40.60	5.05	51.67	38.69	5.53	47.68	36.74	6.09	43.60	34.80	6.71	
	72 (22)	68.32	35.70	43.1	33.97	4.31	64.43	32.21	5.14	56.22	30.45	5.63	51.86	28.64	6.17	47.41	26.83	6.79	
2000 / 0.08	57 (14)	58.21	58.21	55.39	55.39	4.22	52.41	52.41	5.05	49.26	49.26	5.55	45.94	45.94	6.11	42.49	42.49	6.74	
	62 (17)	58.85	56.46	55.65	54.31	4.23	52.44	52.44	5.05	49.31	49.31	5.55	45.99	45.99	6.11	42.53	42.53	6.75	
	63* (17)	59.63	45.33	43.45	43.45	4.24	56.22	43.45	5.06	49.04	39.60	5.54	45.22	37.62	6.09	41.33	35.63	6.72	
	67 (19)	63.69	46.98	45.07	45.07	4.30	60.00	43.15	5.12	52.30	41.19	5.61	48.19	39.19	6.16	44.02	37.19	6.78	
	72 (22)	69.39	37.33	43.99	35.56	4.39	65.35	33.77	5.21	56.82	31.93	5.70	52.39	30.10	6.25	47.82	28.26	6.86	
2250 / 0.09	57 (14)	59.89	59.89	56.91	56.91	4.30	53.77	53.77	5.14	50.48	50.48	5.63	47.00	47.00	6.19	43.39	43.39	6.82	
	62 (17)	59.90	59.90	56.97	56.97	4.30	53.84	53.84	5.14	50.53	50.53	5.64	47.05	47.05	6.19	43.43	43.43	6.82	
	63* (17)	60.36	47.68	45.75	45.75	4.31	56.87	43.81	5.13	49.51	41.81	5.61	45.63	39.77	6.16	41.65	37.68	6.79	
	67 (19)	64.44	49.52	47.55	47.55	4.37	60.65	45.59	5.19	52.76	43.58	5.68	48.58	41.52	6.23	44.33	39.42	6.84	
	72 (22)	70.18	38.87	44.7	37.06	4.47	66.04	35.23	5.29	57.28	33.35	5.77	52.75	31.50	6.31	48.07	29.61	6.92	

See Legend and Notes on page 11.

\* At 75° F entering dry bulb - Tennessee Valley Authority (TVA) rating conditions; all others at 80° F dry bulb.

LEGEND

BF — Bypass Factor

Ewb — Entering Wet- Bulb

KW — Total Unit Power Input

SHC — Sensible Heat Capacity (1000 Btuh)

TC — Total Capacity (1000 Btuh) (net)

NOTES:

1. Direct interpolation is permissible. Do not extrapolate.

2. The following formulas may be used:

$$t_{db} = t_{edb} - \frac{\text{Sensible capacity (Btuh)}}{1.10 \times \text{cfm}}$$

$$t_{db} = t_{ewb} - \frac{\text{total capacity (Btuh)}}{4.5 \times \text{cfm}}$$

Where:  $t_{ewb}$  = Enthalpy of air entering evaporator coils. The SHC is based on 80° F (26.7°C) edb temperature of air entering indoor coil. Below 80° F (26.7°C) edb, subtract (corr factor x cfm) from SHC. Above 80° F (26.7°C) edb, add (corr factor x cfm) to SHC. Correction Factor =  $1.10 \times (1 - BF) \times (edb - 80)$ .

$t_{lwb}$  = Wet-bulb temperature corresponding to enthalpy

air leaving evaporator coil ( $t_{lwb}$ )

### Filter Pressure Drop (IN. W.C.)

FILTER SIZE in. (mm)	CFM																	
	500	600	700	800	900	1000	1100	1200	1300	1400	1500	1600	1700	1800	1900	2000	2100	2200
20X20X1 (508X508X25)	0.05	0.07	0.08	0.10	0.12	0.13	0.14	0.15	—	—	—	—	—	—	—	—	—	—
20X24X1 (508X610x25)	—	—	—	0.08	0.09	0.10	0.11	0.13	0.14	0.15	0.16	—	—	—	—	—	—	
24X30X1 (610X762x25)	—	—	—	0.04	0.05	0.06	0.07	0.07	0.08	0.09	0.10	—	—	—	—	—	—	
24X36X1 (610X914X25)	—	—	—	—	—	—	—	0.06	0.07	0.07	0.08	0.09	0.09	0.10	0.11	0.12	0.13	0.14

### Accessory Electric Heat Pressure Drop (IN. W.C.)

HEATER kW	CFM							
	800	1000	1200	1400	1600	1800	2000	2200
5-20	0.033	0.037	0.042	0.047	0.052	0.060	0.067	0.075

### Wet Coil Delivery\*— (Deduct 10% for 208- Volt Operation)

UNIT SIZE	SPEED TAP	AIR DELIVERY <sup>2</sup>	EXTERNAL STATIC PRESSURE (in. W.C.)									
			0.1	0.2	0.3	0.4	0.5	0.6	0.7	0.8	0.9	1.0
024	1	SCFM	965	818	777	731	670	617	563	489	451	391
	2	SCFM	1003	921	890	850	809	756	700	659	597	539
	3	SCFM	1103	1068	1034	996	962	930	892	821	791	742
030	1	SCFM	1052	1018	984	943	914	879	833	795	732	678
	2	SCFM	1141	1107	1069	1036	1006	974	932	899	856	784
	3	SCFM	1246	1213	1181	1144	1108	1078	1043	1015	973	931
036	1	SCFM	1281	1225	1178	1142	1098	1053	1008	935	878	840
	2	SCFM	1359	1321	1278	1236	1201	1160	1109	1068	992	941
	3	SCFM	1476	1441	1403	1366	1323	1289	1245	1201	1159	1117
042	1	SCFM	1453	1408	1373	1337	1295	1255	1215	1177	1134	1068
	2	SCFM	1544	1507	1475	1436	1397	1359	1326	1290	1246	1201
	3	SCFM	1614	1575	1542	1509	1467	1430	1395	1358	1323	1267
048	1	SCFM	1657	1625	1590	1554	1517	1486	1448	1417	1381	1340
	2	SCFM	1707	1673	1644	1614	1586	1549	1515	1479	1449	1407
	3	SCFM	1931	1900	1870	1840	1809	1778	1749	1714	1683	1646
060	1	SCFM	1837	1798	1753	1716	1677	1637	1590	1549	1497	1445
	2	SCFM	1910	1872	1835	1795	1748	1711	1673	1623	1568	1525
	3	SCFM	2098	2065	2032	1996	1956	1917	1877	1839	1798	1753

\*Air delivery values are based on operating voltage of 230v, wet coil, without filter or electric heater. Deduct filter and electric heater pressure drops to obtain static pressure available for ducting.

NOTES:

1. Do not operate the unit at a cooling airflow that is less than 350 cfm for each 12,000 Btuh of rated cooling capacity. Evaporator coil frosting may occur at airflows below this point.
2. Standard Cubic Feet per Minute.

50ZPB



# TYPICAL FIELD WIRING

50ZPB

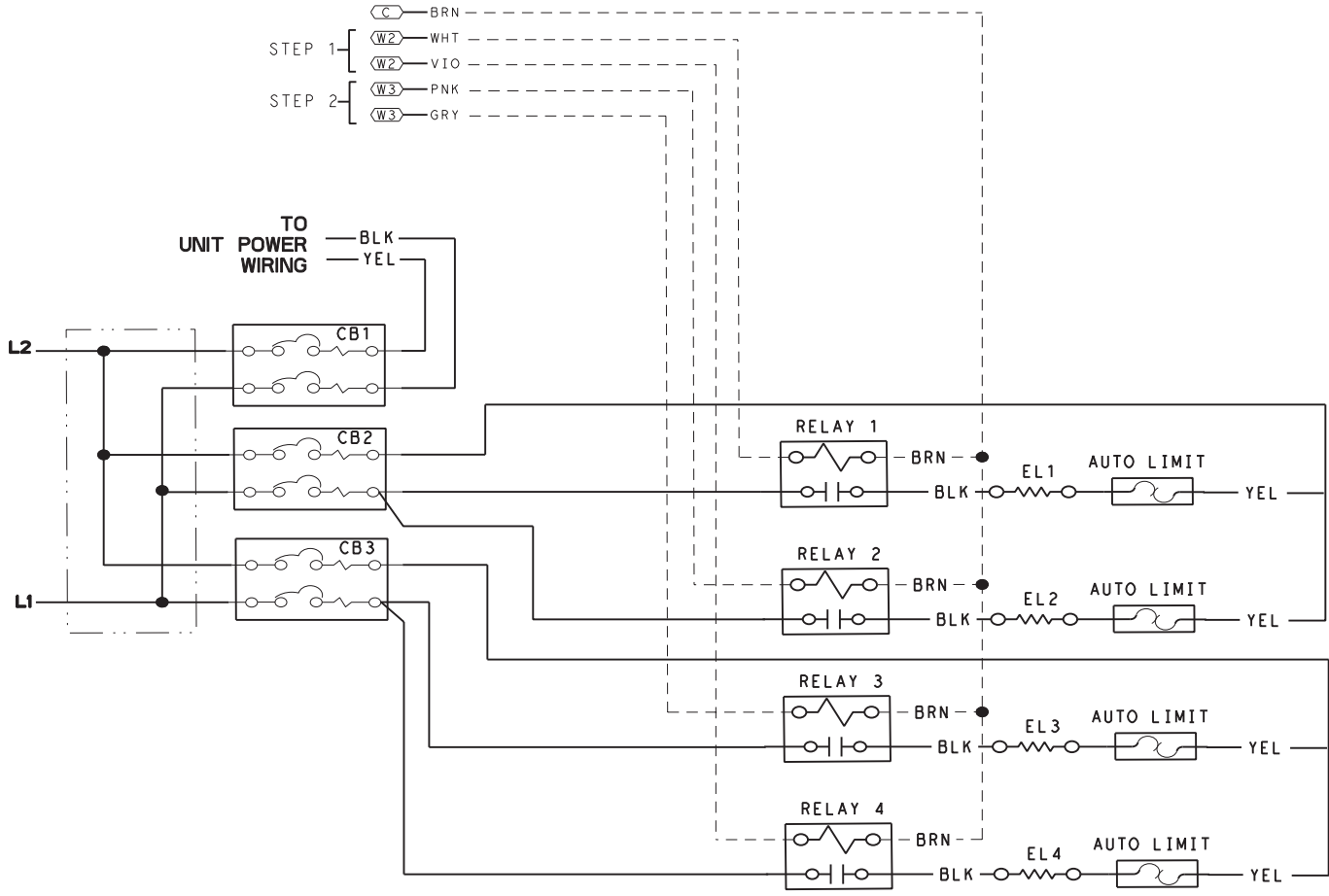

A10025

**NOTE:** 20 kW shown. Smaller heaters have fewer elements and controls.

## Single-Phase Accessory Electric Heater Wiring

## Electrical Data

UNIT	V-PH-HZ	RANGE				OFM	IFM	NOMINAL	FLA		MCA		MOCP
		MIN	MAX	RLA	LRA	FLA	FLA	kW *	208	240	208	230	**
50ZPB024---31	208/230-1-60	197	253	8.5	43.0	0.9	2.8	-/-	-	-	14.3	14.3	20
								3.8/5	18.0	20.8	26.0	29.5	30/30
								5.6/7.5	27.0	31.3	37.3	42.6	40/45
								7.5/10	36.1	41.7	48.6	55.6	50/60
50ZPB030---31	208/230-1-60	197	253	10.9	54.0	0.9	2.8	-/-	-	-	17.4	17.4	25
								3.8/5	18.0	20.8	26.0	29.5	30/30
								5.6/7.5	27.0	31.3	37.3	42.6	40/45
								7.5/10	36.1	41.7	48.6	55.6	50/60
50ZPB036---31	208/230-1-60	197	253	13.1	74.0	1.5	4.1	-/-	-	-	22.0	22.0	30
								3.8/5	18.0	20.8	27.6	31.1	30/35
								5.6/7.5	27.0	31.3	38.9	44.3	40/45
								7.5/10	36.1	41.7	50.3	57.3	60/60
50ZPB042---31	208/230-1-60	197	253	15.7	88.0	1.5	4.1	-/-	-	-	25.2	25.2	40
								3.8/5	18.0	20.8	27.6	31.1	40
								5.6/7.5	27.0	31.3	38.9	44.3	40/45
								7.5/10	36.1	41.7	50.3	57.3	60/60
50ZPB048---31	208/230-1-60	197	253	21.8	117.0	1.5	6.0	-/-	-	-	34.8	34.8	50
								3.8/5	18.0	20.8	34.8	34.8	50/50
								5.6/7.5	27.0	31.3	41.3	46.6	50/50
								7.5/10	36.1	41.7	52.6	59.6	60/60
50ZPB060--32	208/230-1-60	197	253	26.4	134	1.9	7.6	-/-	-	-	42.5	42.5	60
								3.8/5	18.1	20.8	42.5	42.5	60/60
								5.4/7.2	25.9	30	42.5	47	60/60
								7.5/10	36.1	41.7	54.6	61.6	60/70
								11.3/15	54.2	62.5	77.3	87.6	80/90
								15/20	72.1	83.3	99.8	113.6	100/125

\* kW @ 208/240

\*\* HACR Type Circuit breaker

### LEGEND

FLA - Full Load Amps

LRA - Locked Rotor Amps

MCA - Minimum Circuit Amps

MOCP - Maximum Overcurrent Protection

RLA - Rated Load Amps

### NOTES:

- In compliance with NEC (National Electrical Code) requirements for multimotor and combination load equipment (refer to NEC Articles 430 and 440), the overcurrent protective device for the unit shall be Power Supply fuse or circuit breaker.
- Minimum wire size is based on 60°C copper wire. If other than 60°C wire is used, or if length exceeds wire length in table, determine size from NEC.

\*Heater capacity (kW) based on heater voltage of 208v & 240v. If power distribution voltage to unit varies from rated heater voltage, heater kW will vary accordingly.

## OPERATING SEQUENCE

### Cooling Operation

With a call for cooling (Y/G), the contactor is energized which brings on the compressor and outdoor fan. The indoor fan is also energized. When the cooling demand is met, Y and G are de-energized shutting off the contactor. The indoor fan stops after a 60 second delay.

### Heating Operation

With a call for heating (W2), the auxiliary or electric heat energizes along with the indoor blower. In case of staged heating, W3 is energized if the demand is not met. The highest airflow selected is run while the electric heat is in operation. When heating demand is met, W3 and W2 sequentially de-energize shutting off the indoor fan and the electric heater.

### Continuous Fan

With the continuous indoor fan option selected on the thermostat, G is continuously energized keeping the indoor fan running at all times.

## APPLICATION DATA

Condensate trap — A 2-in. (51 mm) condensate trap must be field supplied.

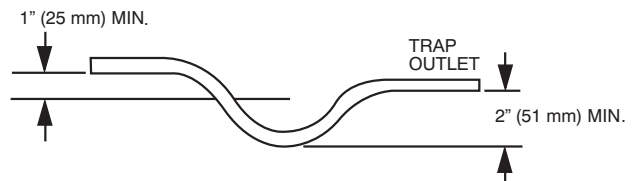

A08001

**Maximum cooling airflow** — To minimize the possibility of condensate blow-off from the evaporator, airflow through the units should not exceed 450 CFM/ton.

**Minimum cooling airflow** — The minimum cooling airflow is 350 cfm/ton.

**Minimum cooling operating outdoor air temperature** — All standard units have a minimum ambient operating temperature of 40°F (4.4°C). With accessory low ambient temperature kit, units can operate at temperatures down to 0°F (-17.8°C).

**Maximum operating outdoor air temperature** — Maximum outdoor operating air temperature for cooling is 125°F (51.7°C).

# TYPICAL INSTALLATION

50ZPB

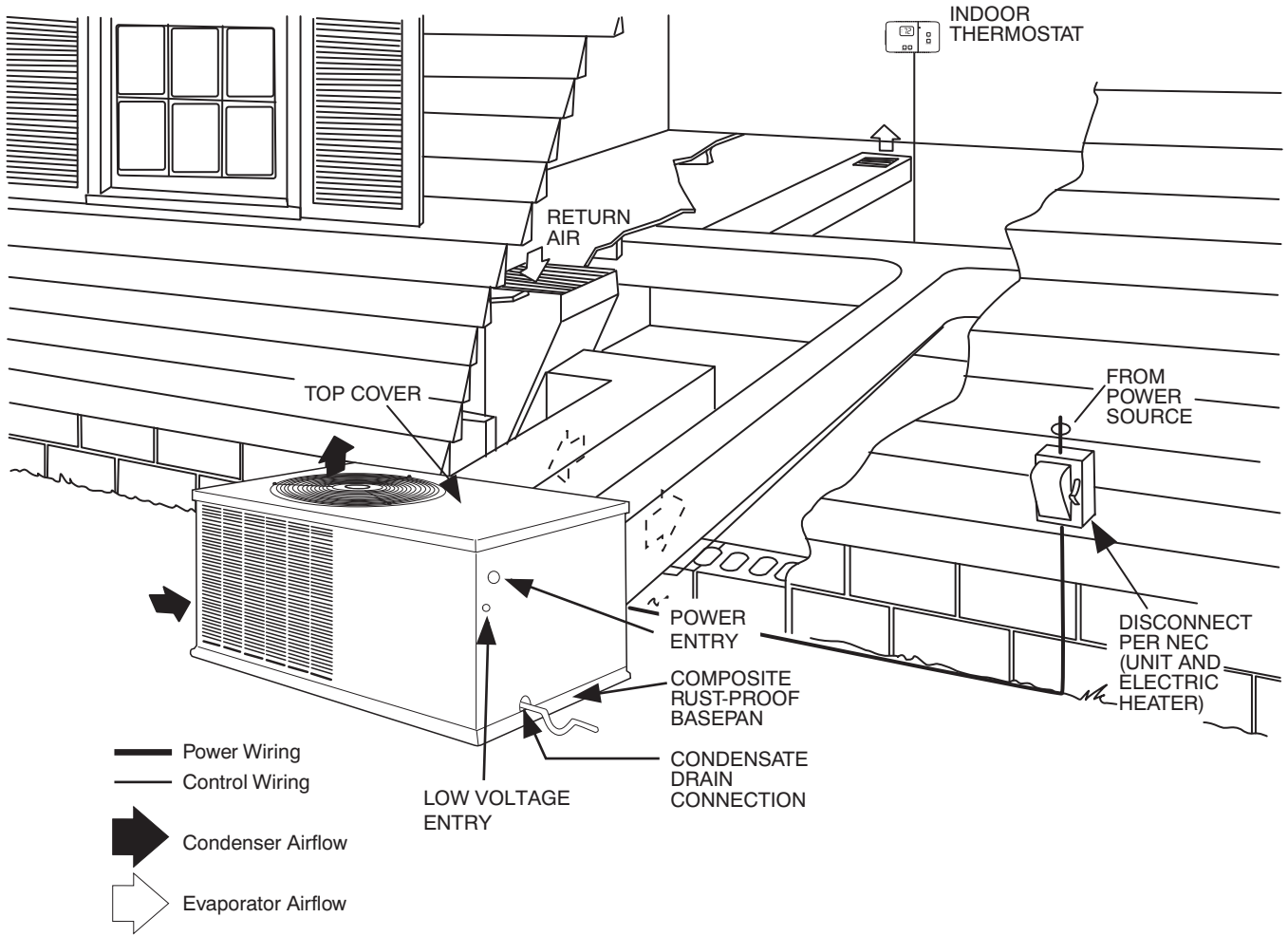

A10135



# ENGINEERS' SPECIFICATION GUIDE

## GENERAL

Furnish and install outdoor package, electrically controlled, air conditioner utilizing a reciprocating or scroll compressor for cooling duty. Unit shall discharge supply air horizontally as shown on contract drawings.

Nominal unit electrical characteristics shall be \_\_\_\_\_ v, \_\_\_\_\_ ph, 60 Hz. The unit shall be capable of satisfactory operation within voltage limits of \_\_\_\_\_ v to \_\_\_\_\_ v. Unit power wiring shall enter unit cabinet at a single location.

Separate power supply shall not be required for electric heat.

## COOLING CAPACITY

Total cooling capacity of the unit shall be \_\_\_\_\_ Btuh or greater, and sensible capacity shall be \_\_\_\_\_ Btuh or greater at conditions of \_\_\_\_\_ cfm indoor air entering unit at \_\_\_\_\_ F dry bulb, \_\_\_\_\_ F wet bulb and outdoor entering air of \_\_\_\_\_ F dry bulb. Total design conditions shall be a minimum of \_\_\_\_\_ Btuh/Watt. The unit shall be capable of cooling operation down to 40°F (4.4°C) as shipped from the factory.

## CABINET

Unit cabinet shall be constructed of phosphated, bonderized, zinc-coated, prepainted steel. Basepan shall be made of a single-piece non-corrosive, composite material.

Evaporator-fan compartment interior cabinet surfaces shall be insulated with a minimum 1/2-in. (12.7 mm) thick, flexible fiberglass insulation, coated on the air side with aluminum foil.

Cabinet panels shall be easily removable for servicing.

Outdoor coil shall be protected by metal louvered panels.

## COMPRESSOR

Compressor shall be fully hermetic type with external vibration isolation.

## CONDENSER SECTION

Condenser fan shall be of the direct-driven propeller type blades, riveted to corrosion-resistant spiders, and shall be dynamically balanced and discharge air vertically upwards.

Condenser coils shall have aluminum-plate fins mechanically bonded to copper tubes with all joints brazed.

Tube sheet openings shall be belled to prevent tube wear.

## EVAPORATOR SECTION

Fan shall be multi-speed with direct drive motor as shown on the equipment drawings.

Fan wheel shall be made from steel, be double-inlet type with forward-curved blades with a corrosion-resistant finish and dynamically balanced.

Evaporator coils shall have aluminum-plate fins mechanically bonded to copper tubes with all joints brazed.

Tube sheet openings shall be belled to prevent tube wear.

## MOTORS

Compressor motors shall be of the refrigerant cooled type with line break thermal and current overload protection.

All fan motors shall have permanently lubricated bearings, and inherent automatic reset thermal overload protection.

Condenser fan motor shall be totally enclosed.

## REFRIGERANT SYSTEM

Refrigerant system shall include fixed orifice or TXV metering system.

## CONTROLS

Unit shall be complete with self-contained low voltage control circuit.

## APPROVALS

Unit shall be UL listed as a total package for safety requirements. All wiring shall be in accordance with NEC.

Unit shall be rated in accordance with AHRI Standards 210/240.

Cabinet insulation shall conform to ASHRAE Standard 62.2

Insulation and adhesive shall meet NFPA 90A requirements for flame spread and smoke generation.

Unit shall have a sloped drain pan that conforms to ASHRAE Standard 62.2.

## ACCESSORIES

Field-installed accessories shall include solid-state compressor short-cycle device, outdoor thermostat, room thermostats, electric heaters with single-point connection, crankcase heater, and low-ambient kit.

